



# Product catalog

“

**AVS RÖMER, YOUR SPECIALIST  
FOR CUSTOMIZED SOLUTIONS!**



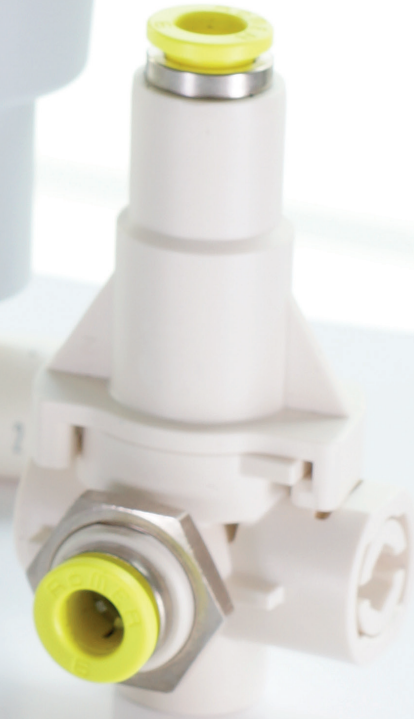
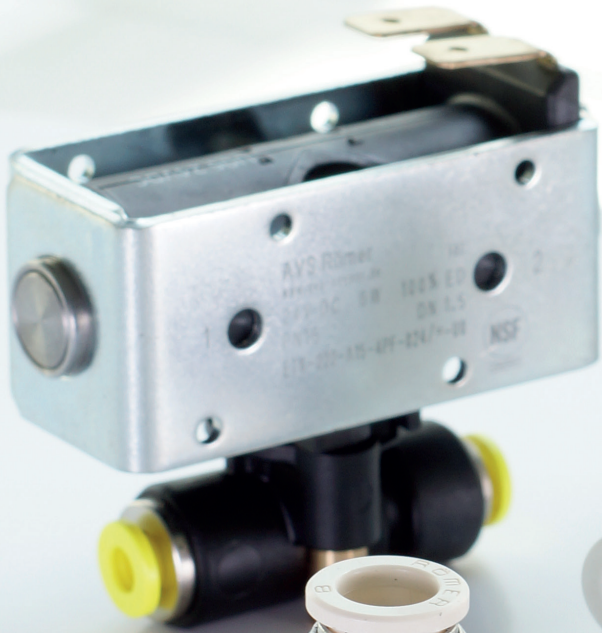

**2-Way Shut-off Valve**
**Abbildung**

Price group	34		PN	10							Plastic PVDF			
Ambient-Temp. $T_{min}$ 0 °C, $T_{max}$ +60 °C														
Med.-Temp. $T_{min}$ 0 °C, $T_{max}$ +80 °C														
for tube OD	L	L1	L2	D1	D2	M	S	S1	S2	Weight in [g]	Type	Order number	Price	
8	73.4	44.9	19.5	21	31.8	M22x1.5	8	27	19	75,6	ASH-958V-8FF	637756	a.A.	
10	68	44,9	19.5	21	31,8	M22x1.5	8	27	19	68,6	ASH-958V-10FF	637757	a. A.	
12	68	44.9	19.5	21	31.8	M22x1.5	8	27	19	65.5	ASH-958V-12FF	637756	a. A.	

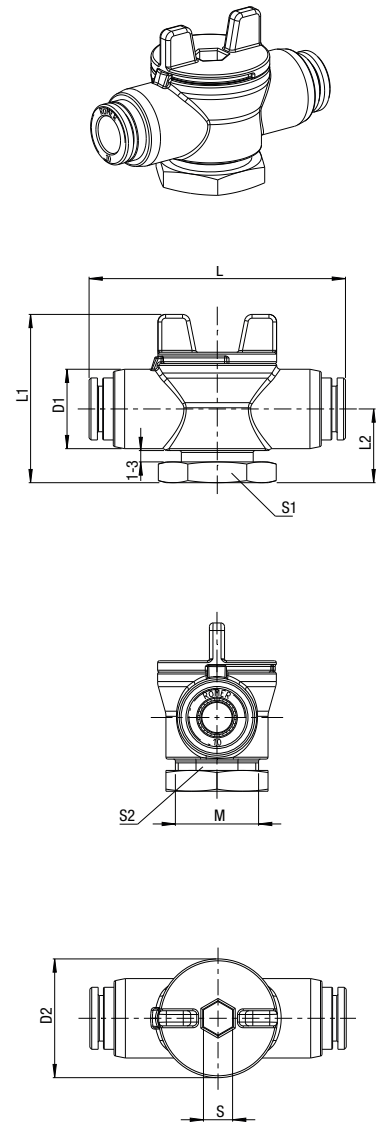



# 10,500

products and variants through **modular design**,  
**different configurations** and **custom solutions**

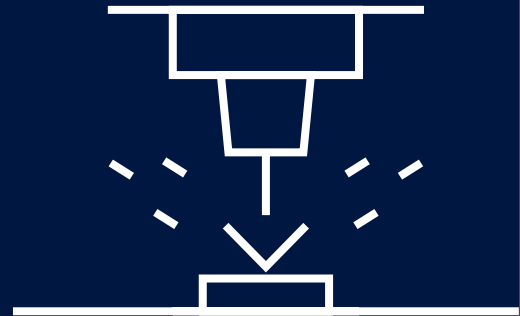

## ○ Since 1970

Successful family business for over **50 years**

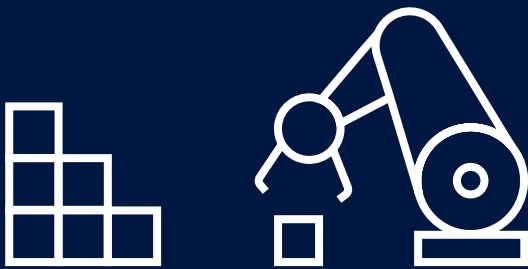

## From 1 to 1,000,000

**Flexibility** in the number of pieces

## ○ 14 %

of the electricity demand is  
generated with **our own PV system**

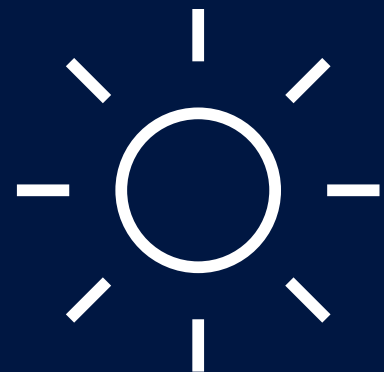



# Worldwide

International customers from the market segments  
**Food & Beverage, Industrial, Life Science**

J. C. Römer Foundation since **2012**  
to promote young technical talent

## 3 core values

### The Römer family

We live cohesion and trust

### Customer orientation

We are committed to quality and service

### Down-to-earth self-confidence

We stand by our word

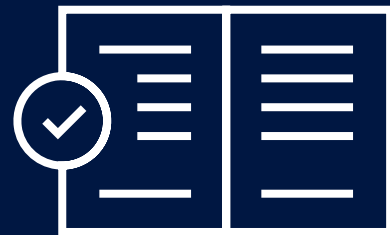

**3,500**

Catalog products with variants

## 3 locations

Grafenau, Langenberg and Switzerland



Shipping to  
different countries

**48**

# Certifications and approvals

## AVS Römer Quality and Environmental Management

Our ISO certifications confirm the sustainable environmental policy and the high quality at AVS Römer. The implemented management systems according to ISO 9001:2015 and ISO 14001:2015 ensure an improvement process, which continuously expands the high standard at our company.



## Product approvals

For numerous applications, compliance with certain safety standards is necessary. Among other things, this requires a high degree of cleanliness as well as special design guidelines and materials. A large number of our products meet these stringent requirements.



## Product and material conformity

AVS Römer products are particularly well-suited for use in various areas due to their compliance with certain guidelines and standards. Further conformities, approvals and certifications on request.







**MADE IN  
GERMANY**

**AVS Römer GmbH & Co. KG**  
Reismühle 3  
94481 Grafenau  
Germany

**AVS G. Roemer Schweiz AG**  
Heidelbergstrasse 9  
8355 Aadorf  
Switzerland

DE GB US

Phone: +49 8552 4076 300  
E-Mail: [info@avs-roemer.de](mailto:info@avs-roemer.de)  
[www.avs-roemer.de](http://www.avs-roemer.de)

CH ES BE FR IT

Phone: +41 32 377 22 11  
E-Mail: [info@avs-roemer.ch](mailto:info@avs-roemer.ch)  
[www.avs-roemer.ch](http://www.avs-roemer.ch)

  
**FSC**  
[www.fsc.org](http://www.fsc.org)  
MIX  
Paper from  
responsible sources  
FSC® C114687

